REV 4T

OWNER'S MANUAL

Thank you for choosing
Betamotor. We hope you enjoy
your motorcycle.
This booklet provides
the information you will need
to use and maintain
your bike properly.

*The details and specifications given in
this manual do not commit BETAMOTOR
S.p.A, who reserve the right to make
changes to their models at any time.*

CAUTION

It is important, after the first hour of break-in, to check the tightness of all fasteners, paying particular attention to the following:

- Footrest brackets
- Front and rear brake discs
- Wheel spokes
- Shockabsorber bolt
- Engine bolts
- Rear sprocket
- Exhaust bolts

Index

Pag.

CHAPTER 1: GENERAL INFORMATION

INDEX OF TOPICS

Principal parts.....	44
Vehicle identification details.....	44
Engine identification details.....	44
Console and controls.....	44
Technical details.....	45
Wiring scheme.....	46

CHAPTER 2: Operation and Use

INDEX OF TOPICS

Filling the fuel tank.....	48
Start-up	48
Break-in	50
Checks and maintenance before and after use off-road	50
Recommended lubricants and liquids.....	51

CHAPTER 3: MAINTENANCE AND CHECKS

INDEX OF TOPICS

Lubrication circuit.....	53
Engine oil.....	54
Brake master cylinder fluid	57
Brakes circuit bleeding	59
Clutch master cylinder fluid	60
Clutch circuit bleeding.....	60
Fork oil	61
Air filter	62
Sparkplug	63
Front brake	64
Rear brake	65
Coolant	66
Checks after cleaning	66
Scheduled maintenance	67

CHAPTER 4: ADJUSTMENTS

INDEX OF TOPICS

Brake adjustment	69
Clutch adjustment	69
Carburettor	70
Tickover adjustment	70
Throttle free clearance adjustment	70
Steering paly check and adjustment.....	71
Chain tension	71
Front suspension adjustment	72
Rear shockabsorber adjustment	72

CHAPTER 5: WHAT TO DO IN AN EMERGENCY

INDEX OF TOPICS

Troubleshooting.....	74
----------------------	----



Chapter 1

General information

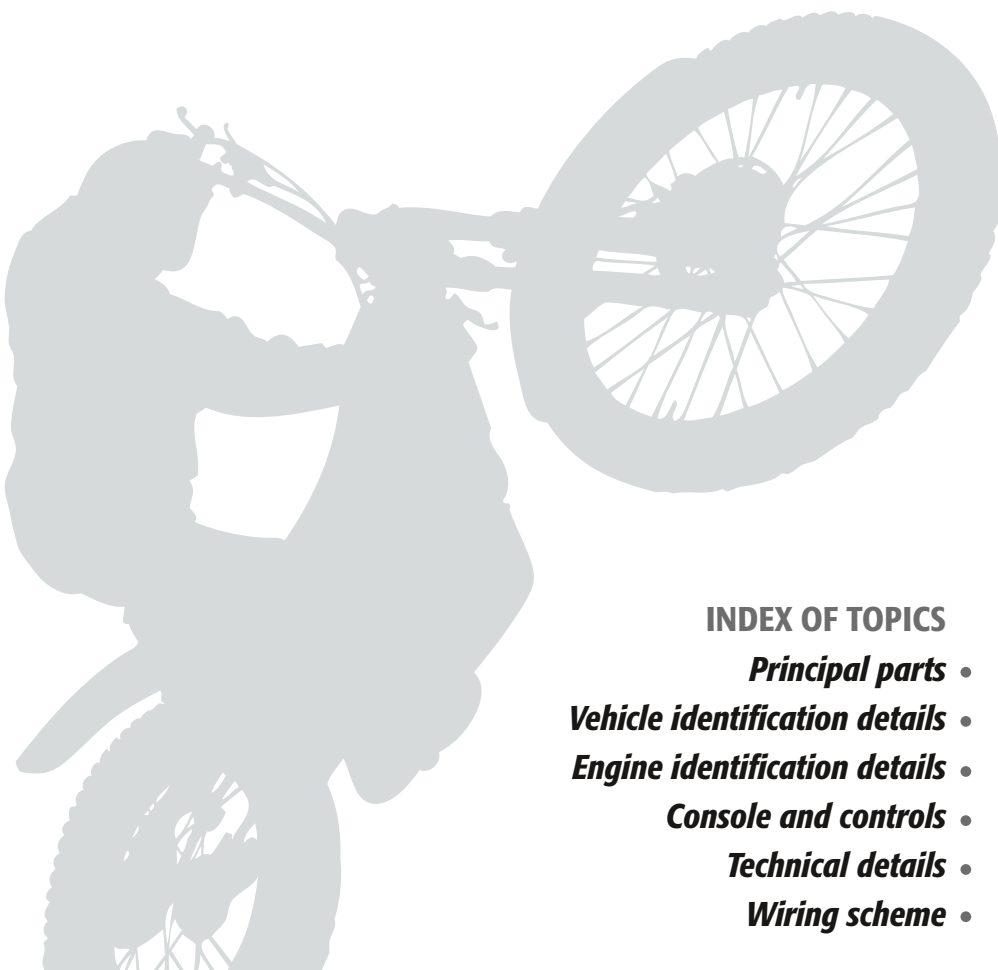

INDEX OF TOPICS

- Principal parts*** •
- Vehicle identification details*** •
- Engine identification details*** •
- Console and controls*** •
- Technical details*** •
- Wiring scheme*** •

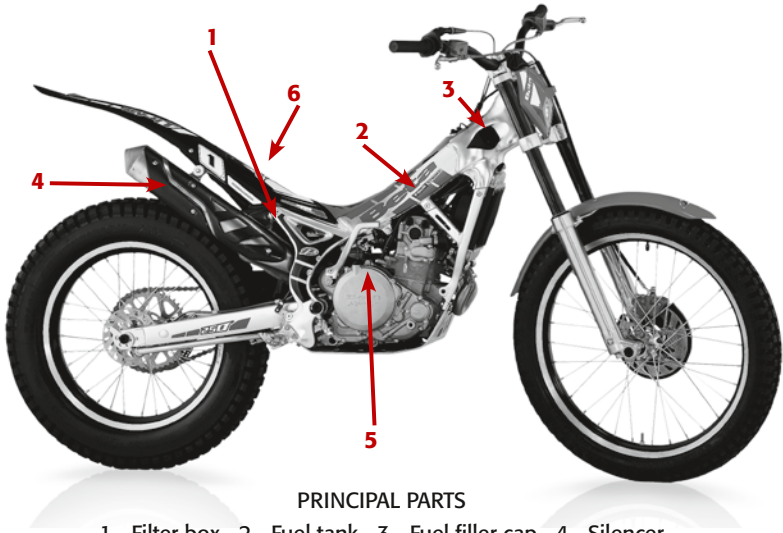

PRINCIPAL PARTS

- 1 - Filter box 2 - Fuel tank 3 - Fuel filler cap 4 - Silencer
- 5 - Kickstart lever 6 - Filter cover

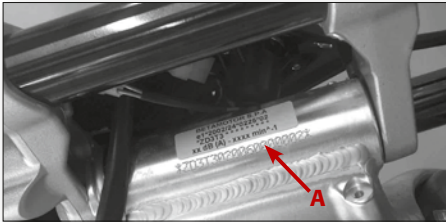

VEHICLE IDENTIFICATION DETAILS

Frame identification

The frame identification details (A) are stamped on the right-hand side of the headstock.

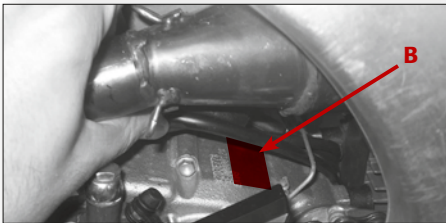

ENGINE IDENTIFICATION DETAILS

The engine identification details (B) are stamped in the area indicated in the picture.

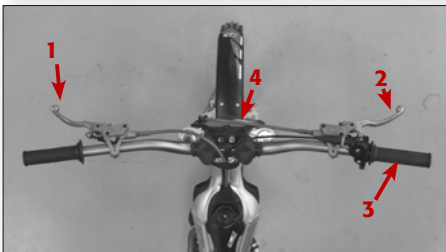

CONSOLE AND CONTROLS

- 1 Clutch lever
- 2 Front brake lever
- 3 Throttle twistgrip
- 4 Hot start lever

TECHNICAL DETAILS**Vehicle weight**

- in running order (dry) 75 kg

Dimensions

- overall length 2015 mm
- overall width 825 mm
- overall height 1.160 mm
- wheelbase 1.319 mm
- seat height 680 mm
- ground clearance 320 mm

Tyres

- pressure kPa front 39-44 / rear 29-34
- tyre sizes front 2.75- 21" (Tube Type)
rear 4.00 - 18" (X11Tubeless)

Capacities

- fuel tank 2.2 litres
- cooling circuit 600 cc
- engine oil BARDAHL XT C60 15W50 - 900 cc

Front suspension

- hydraulic forks with 38 mm stanchions, rebound and spring preload adjustment

Fork oil capacities:

- right leg 370 cc
- left leg 350 cc

Rear suspension

- progressive hydraulic monoshock, with rebound and spring preload adjustment

Front and rear brake discs

- disc, with hydraulic control

Engine

- type Single cylinder, 4-stroke, 4 valve head, SOHC. (ZD3E77)
- bore x stroke 77x53.6 mm
- displacement (cm³) 249.6
- compression ratio 11.5:1
- liquid cooling
- digital electronic ignition with magneto flywheel alternator and variable advance
- starting by kickstart
- sparkplug NGK CR7EB

Fuel system

- carburettor MIKUNI SE BSR 33-79
- jet 127.5-27.5 max-min
- runs on unleaded petrol

WIRING SCHEME

CAUTION: Do not run the engine with the voltage regulator connected to the electrical generator without also connecting the vehicle wiring harness (central system). Doing so could cause damage to the regulator itself.

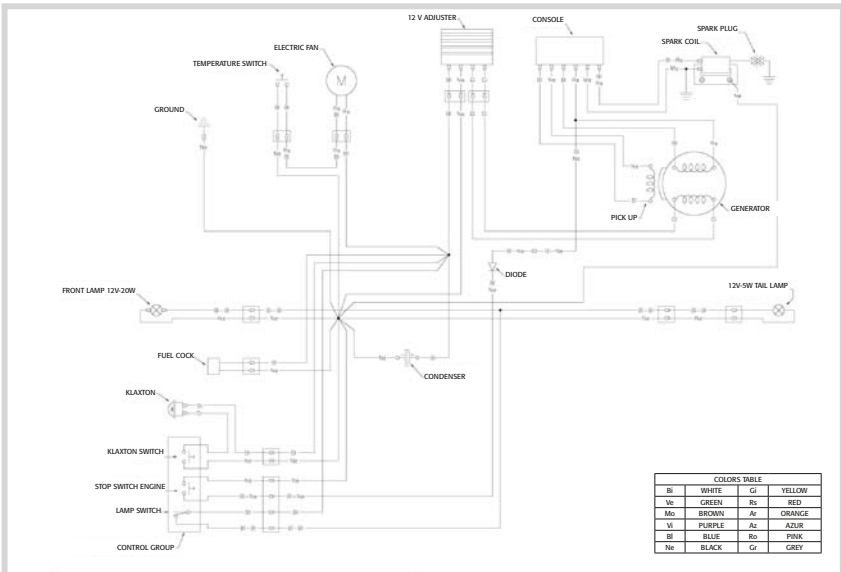
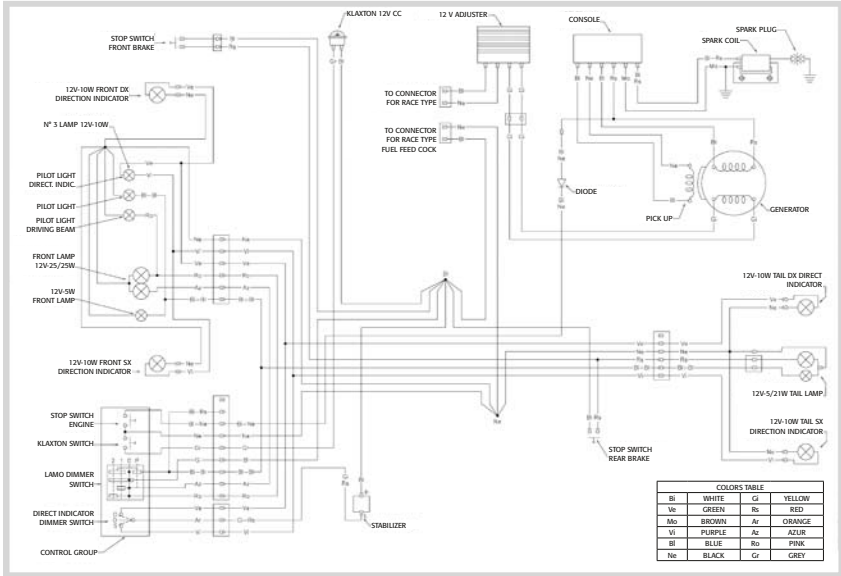

Chapter 2

Operation and Use

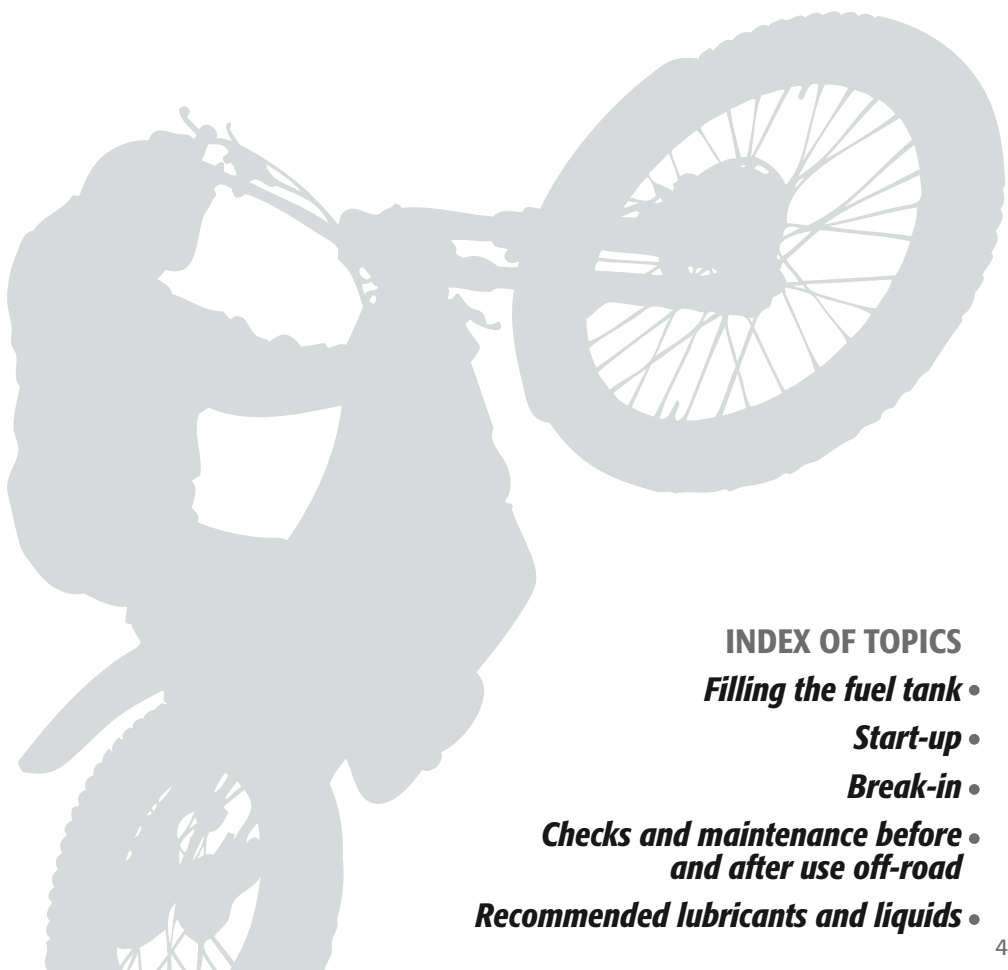

INDEX OF TOPICS

Filling the fuel tank •

Start-up •

Break-in •

***Checks and maintenance before
and after use off-road***

Recommended lubricants and liquids •

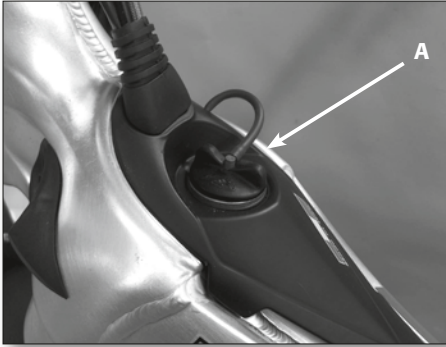

FILLING THE FUEL TANK

Remove filler cap A. The capacity of the fuel tank is approximately 2.2 litres.

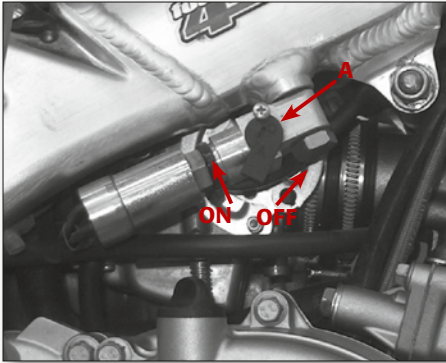

START-UP

- 1 Put the gearbox in neutral.
- 2 **WITHOUT** opening the throttle, press the kickstart lever progressively downwards, avoiding violent strokes, to the bottom of its travel.

NOTE:

A long period with the engine out of use, such as when the vehicle is on its side, can lead to a lowering of the fuel level in the carburettor float bowl, making the bike hard to start.

in this case open manually the fuel tap by turning the lever A clockwise (ON)

Once the engine has started, **reclose the fuel tap.**

STARTING THE ENGINE FROM COLD

- 1 Put the gearbox in neutral.
- 2 Operate the choke lever B (black knob) by pulling it outwards.
- 3 **WITHOUT** opening the throttle, press the kickstart lever progressively downwards, avoiding violent strokes, to the bottom of its travel.
- 4 Reclose the choke as soon as the engine has warmed up (the radiator will be warm).

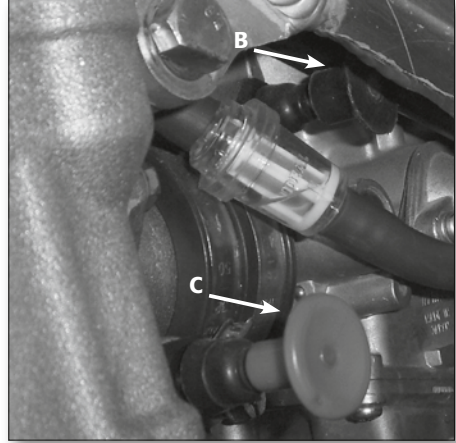
**STARTING THE ENGINE WHEN HOT**

- 1 Put the gearbox in neutral.
- 2 Operate the hot start by pulling outward the knob C (the red one)
- 3 **WITHOUT** opening the throttle, press the kickstart lever progressively downwards, avoiding violent strokes, to the bottom of its travel.
- 4 Release the hot start after the engine has run for some instants

STARTING WHEN THE BIKE HAS FALLEN OVER

If the bike falls over, the carburettor float bowl may empty.

- 1 Open manually the fuel tap by turning the lever A clockwise (ON)
- 2 Put the gearbox in neutral.
- 3 Operate the Hot Start knob (C).
- 4 **WITHOUT** opening the throttle, press the kickstart lever progressively downwards, avoiding violent strokes, **to the bottom of its travel.**
- 5 Close the fuel tap.

BREAK-IN

The break-in period lasts for about 10 hours of use. During this period, please observe the following recommendations:

- 1 For the first 3 hours of use, the engine should only be used at up to 50% of its power. The engine speed should not exceed 7000 rpm.
- 2 For the next 7 hours of use, the engine should only be used at up to 75% of its power.
- 3 Warm the engine up well before using the bike.
- 4 Avoid travelling at a constant speed: varying the speed makes the components bed in uniformly and in less time.

CAUTION:

After the first three hours (or two fills of petrol), change the engine oil.

- *Always use super unleaded petrol.*
- *After the first trip off-road, check all the nuts and bolts.*

CHECKS AND MAINTENANCE BEFORE AND AFTER USE OFF-ROAD

To avoid unpleasant surprises while operating the vehicle, we recommend that you perform a series of checks and maintenance jobs both before and after use. In fact, dedicating just a few minutes to these checks and jobs will not only make riding safer, but can save you time and money. Proceed as follows:

Tyres

Check the pressure, general condition and tread depth.

Spokes

Check that the tension is correct.

Nuts and bolts

Go over all the nuts and bolts.

Chain

Check the tension (clearance 20 mm) and, if necessary, grease it.

Air filter

Clean the filter and soak it in air filter oil.

Note:

Check that you have the vehicle's identification documents. On cold days, before setting off we advise that you run the engine, as a minimum, for the time required to reach the correct operating temperature. Every time the vehicle is used off-road it needs to be cleaned carefully.

RECOMMENDED LUBRICANTS AND LIQUIDS

To promote better operation and longer life, we recommend that you preferably use the products listed in the table:

TYPE OF PRODUCT	TECHNICAL SPECIFICATIONS
Engine oil	Bardahl XT C60 15W50
Brake and clutch fluid	Bardahl brake fluid dot 4
Fork oil	Idemitsu oj-racing-01
	Bel ray "mc 10sae 5"
Grease for linkages	Bardahl outboard grease
Coolant	Bardahl permanent
Filter oil	Bardahl oil filter

NOTE:

When changing the fluids, we recommend that you adhere strictly to the table shown.

Chapter 3

Maintenance and checks

A large, light gray silhouette of a person wearing a helmet and working on a motorcycle. The person is positioned on the left side of the page, leaning over the bike. The motorcycle's rear wheel and tire are prominent on the right side. The background is white, and the overall image is semi-transparent, allowing the text to be overlaid.

INDEX OF TOPICS

Lubrication Circuit •

Engine Oil •

Brake master cylinder fluid •

Brakes circuit bleeding •

Clutch master cylinder fluid •

Clutch circuit bleeding •

Fork oil •

Air filter •

Sparkplug •

Front brake •

Rear brake •

Coolant •

Checks after cleaning •

Scheduled maintenance •

LUBRICATION CIRCUIT

The output oil pump (1) draws in oil from the area at the base of the gearbox through its own mesh oil filter (2) and then sends it to the paper oil filter (3). From here the oil, starting from the bypass valve (4), is directed in three different directions: by means of a jet (5) it lubricates the piston pin and takes heat from the crown of the piston; and it passes through two pipes, one of which (6) takes it to the crankshaft to lubricate the roller bearing on the crankpin; the other (7), whose flow is regulated by a calibrated hole on the cylinder base gasket (8), feeds the valvegear (9). The oil then returns to the base of the crank chamber from the piston, the conrod assembly and the cylinder walls, and is drawn in by the scavenge pump (10) through the mesh filter (11). It is pumped through special jets (12) and lubricates the transmission gears. The oil in the cylinder head, however, returns to the base of the gearbox passing through the timing case and the inner clutch casing.

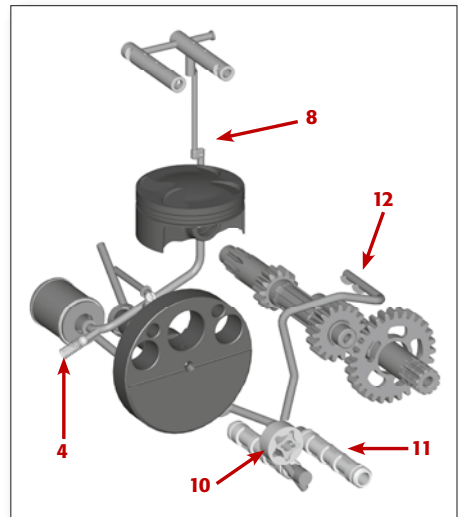
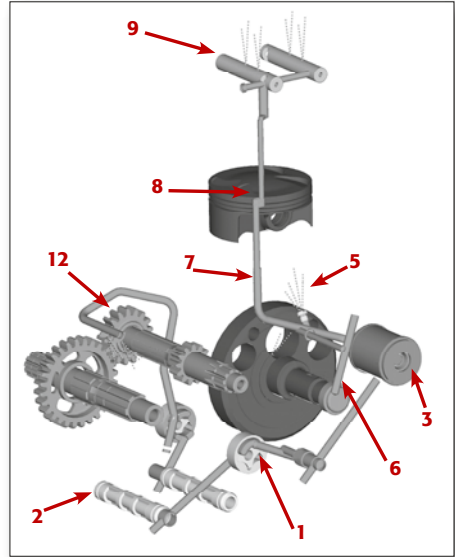

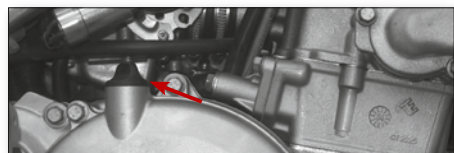
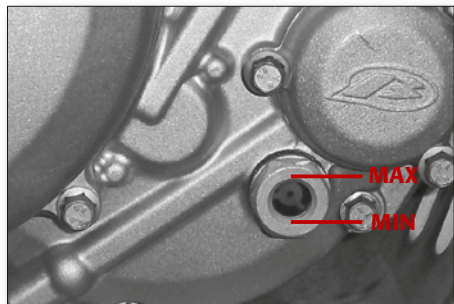

ENGINE OIL

Use only fully synthetic oils of a reputable brand (BARDAHL XTC60 15W50).

CHECKING THE ENGINE OIL LEVEL

The engine oil level must be checked when the engine is warm. Run the engine for several minutes and then switch it off. Place the bike on a flat surface in such a way that it is perfectly vertical.

Wait a few minutes and then check the oil level in the sightglass located in the clutch casing (right-hand side of the engine). The level must be between the limits indicated in the picture.

If necessary, remove the oil filler plug and top up the level.

N.B. Running the engine with too little oil causes excessive wear to the engine components.

CHANGING THE ENGINE OIL

N.B. At each oil change, the mesh filters must be cleaned and the paper filter replaced.

N.B. The oil change must be carried out when the engine is at working temperature. Be careful not to scald yourself with the hot oil.

After the engine has reached operating temperature, switch the bike off and stand it upright.

Unscrew the oil drainplug and let all the oil flow out into a drain pan. Thoroughly clean the magnet on the drainplug to get rid of the metallic impurities that it has collected.

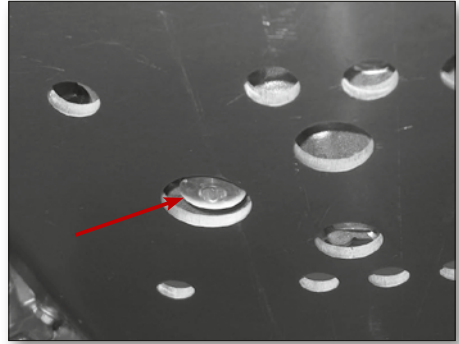

Unscrew the plug in the left-hand casing and use pliers to extract the filter. Clean it carefully and blow it through with compressed air. Check for damage to the O-rings, and replace them if necessary. Refit all the parts and tighten the plug to 15 Nm.

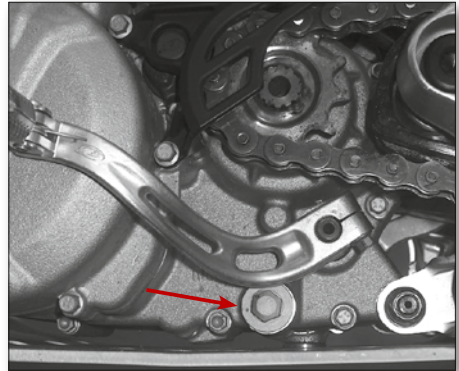

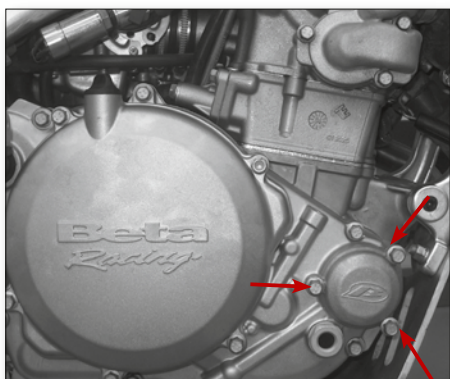

Carry out the same procedure for the output mesh filter, for which the access is via the right-hand engine casing.

Position a container under the bike, near the cover for the paper filter, and unscrew the bolts on the filter cover.

Then extract the paper filter using pliers. Check the condition of the O-ring too, and replace it if necessary.

Change the filter and refit the cover, tightening the three M6x20 bolts to 10 Nm.

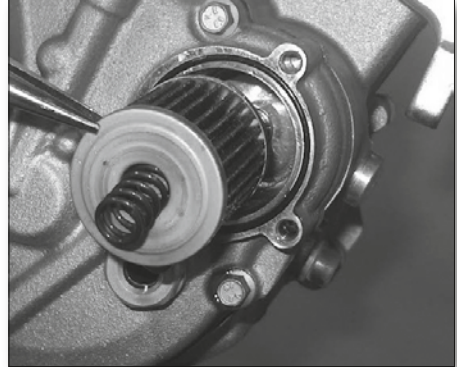

Refit the oil drainplug, tightening it to 20 Nm, and refill with 0.9 litres of engine oil (BARDHAL XTC60 15W50). Finally, tighten the oil filler plug (A) to 10 Nm.

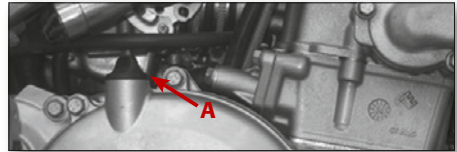

BRAKE MASTER CYLINDER FLUID

Front brake

Use the sight-glass (A) to check the brake fluid level. There must always be enough brake fluid for the level to be visible in the sight-glass. If there is not enough, the fluid must be brought up to the correct level. To do this, refill the reservoir by unscrewing the two screws (B), removing the filler cap (C) and topping up the fluid.

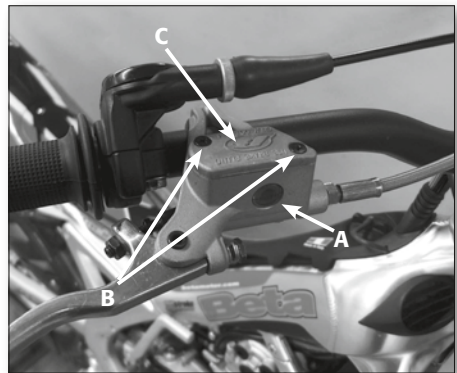

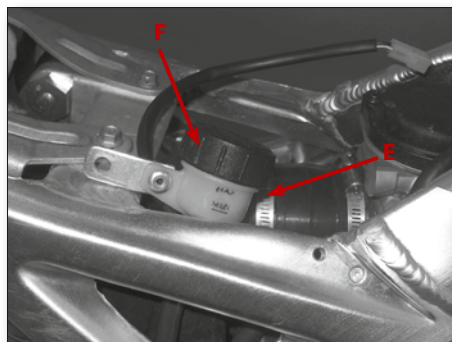
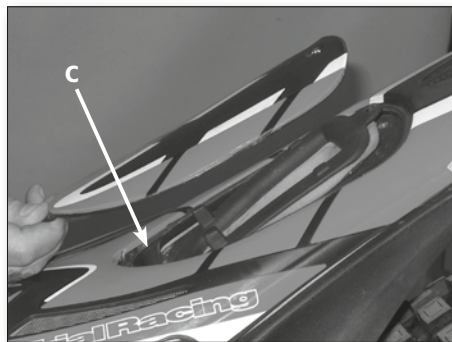
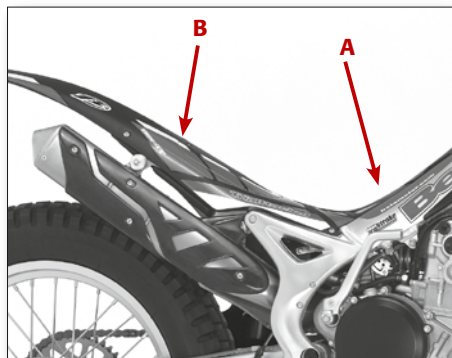

Rear brake

Before you can check the rear brake fluid, you must first remove the rear mudguard by unscrewing the seven retaining screws (four on the outside, one on the tank (A), one securing the filter cover (B) and one inside the filter box (C)). Then look through the brake fluid reservoir (E) to check the fluid. The level must never fall below the minimum level line marked on the reservoir (E). To top up the level, remove the filter cap (F) and refill with brake fluid.

Warning

If you notice softness in the lever, there could be an air bubble in the system. In this case, bleed the rear brake system. Alternatively, contact your dealer immediately.

*Note:
Change the fluids in accordance with the intervals in the table on page 29, using the lubricants recommended on page 13.*

BLEEDING THE FRONT BRAKE

To bleed the air from the front brake system, follow the steps below:

- Remove the rubber cap (A) from the bleed-nipple (B).

Take off the clutch fluid reservoir cover.

- Fit one end of a small transparent tube over the bleed-nipple (B), and insert the other end into a container.
- Pump 2/3 times with the lever and hold the lever in.
- Unscrew the bleed-nipple, allowing the fluid to flow through the tube.
- Reclose the bleed-nipple and release the lever.
- If you can see air bubbles through the tube, repeat the above operations until the fluid that comes out is free of air.

Note:

During this operation it is important that you top up the master-cylinder reservoir continually, to compensate for the fluid which has been pumped out.

- Remove the small tube.
- Refit the rubber cap.

Note:

Handle brake fluid with care: being corrosive, it can damage painted or plastic parts irreparably.

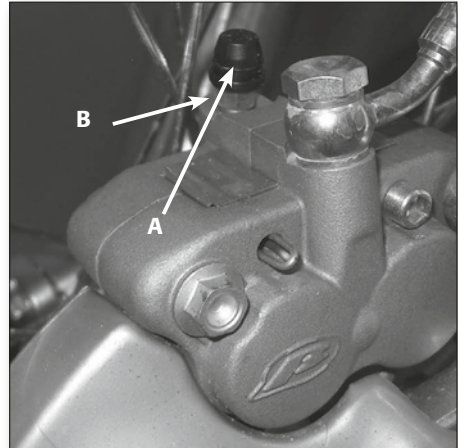
**BLEEDING THE REAR BRAKE**

To bleed the air from the rear brake system, follow the steps below:

- Remove the rubber cap C.
- Take off the clutch fluid reservoir cover.
- Fit one end of a small transparent tube over the bleed-nipple D, and insert the other end into a container.
- Pump 2/3 times with the brake pedal and hold the pedal down.
- Unscrew the bleed-nipple, allowing the fluid to flow through the tube.

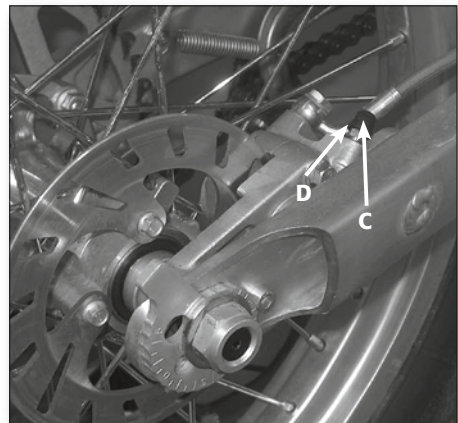

- Reclose the bleed-nipple and release the pedal.
- If bubbles of air are visible through the tube, repeat the above operations until the fluid that comes out is free of air.

Note:

During this operation it is important to top up the master-cylinder reservoir continually, to compensate for the fluid which has been pumped out.

- Remove the small tube.
- Refit the rubber cap.

Note:

Handle brake fluid with care: being corrosive, it can damage painted or plastic parts irreparably.

CLUTCH MASTER CYLINDER FLUID

Check the fluid in the reservoir. The level must never be below half-way up the reservoir. To bring the clutch fluid up to the correct level, refill the reservoir by unscrewing the two screws A, removing the filler cap B and topping up the fluid.

Note:

Change the fluids in accordance with the intervals in the table on page 29, using the lubricants recommended on page 13.

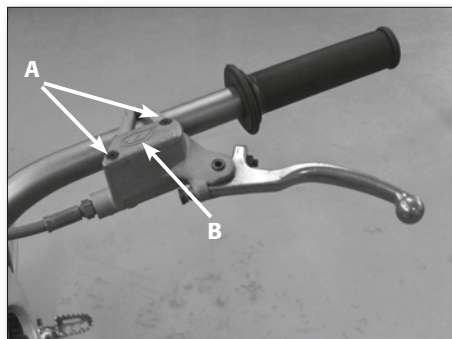

BLEEDING THE CLUTCH SYSTEM

To bleed the air from the clutch system, follow the steps below:

- Remove the rubber cap from the bleed-nipple C.
- Take off the clutch fluid reservoir cover.
- Fit one end of a small transparent tube over the bleed-nipple D, and insert the other end into a container.
- Pump 2/3 times with the lever and hold the lever down.
- Unscrew the bleed-nipple, allowing the fluid to flow through the tube.
- Reclose the bleed-nipple and release the lever.

- If you can see air bubbles through the tube, repeat the above operations until the fluid that comes out is free of air.

Note:

During this operation it is important that you top up the master-cylinder reservoir continually, to compensate for the fluid which has been pumped out.

- Remove the small tube.
- Refit the rubber cap.

Note:

Handle brake fluid with care: since it is corrosive, it can cause irreparable damage to painted or plastic parts

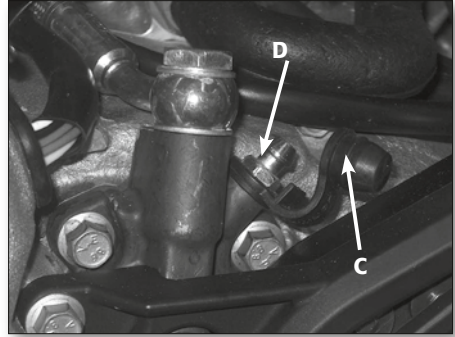

FORK OIL

Right fork leg

To change the fork oil, follow the steps below:

- 1 Take out the front wheel.
- 2 Remove the handlebars.
- 3 Slack off the fork stanchion pinch bolts (A) and slide out the complete fork leg.
- 4 Unscrew the upper cap.
- 5 Unscrew the locknut securing the cap and remove it.
- 6 Undo the screw retaining the cartridge (located under the fork leg) and extract the cartridge.
- 7 Drain the fork leg and cartridge completely of oil.
- 8 Refit the cartridge to the fork leg, tightening the retaining bolt, then refill with oil (OJ01), thus charging the cartridge, up to the level shown in the diagram (with fork leg fully compressed).
- 9 Refit the cap to the damper rod, tighten the locknut, and screw the cap onto the stanchion, with the fork leg fully extended.
- 10 Refit all remaining parts.

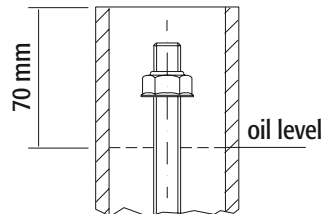
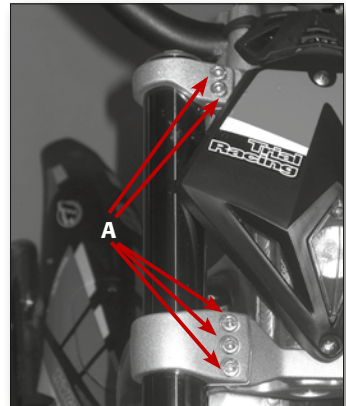

Note:

Recommended tightening torque 7.8: 9.1 Nm.

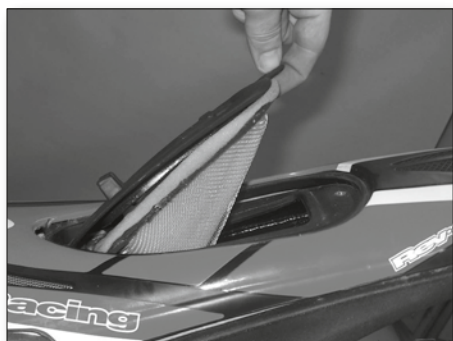
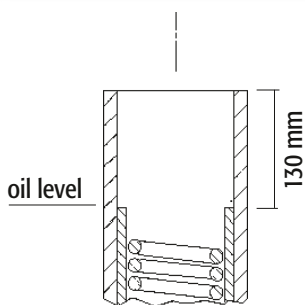
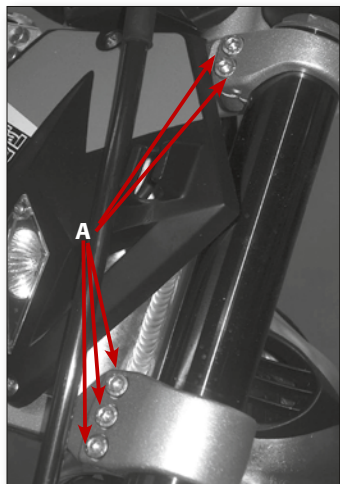

Left fork leg

To change the fork oil, follow the steps below:

- 1) Take out the front wheel.
- 2) Remove the handlebars
- 3) Slack off the fork stanchion pinch bolts (A).
- 4) Unscrew the fork leg cap.
- 5) Remove the spring and drain the oil completely.
- 6) Refill with fork with oil (OJ01) up to the level shown in the diagram, with fork leg fully compressed. Then refit the spring.

Note:

Change the fluids in accordance with the intervals in the table on page 29, using the lubricants recommended on page 13.

Check periodically and, if necessary, remove any residues of dirt that may remain between the fork seal and the dust cover, by removing the dust cover.

Note:

Recommended tightening torque 7.8: 9.1 Nm.

AIR FILTER

To access the filter, you only need to unscrew the rear retaining screw for the cover and remove the cover itself, then follow the steps below:

- Remove the front bolt securing the filter.
- Remove the filter frame and the filter.
- Wash it with soap and water.
- Dry it.
- Soak it in filter oil, squeezing out the excess so that it does not drip.
- If necessary, clean the inside of the filter box too.
- Refit all parts. We recommend assembling the frame to the filter in advance.

Note:

- If the filter is very dirty, wash it first with petrol, and then with water and shampoo.
- If you find that the filter is damaged, replace it immediately.

Warning:

After each time the air filter box is opened, check that nothing is left inside which could end up in the engine and damage it. Clean the filter each time the bike is used off-road.

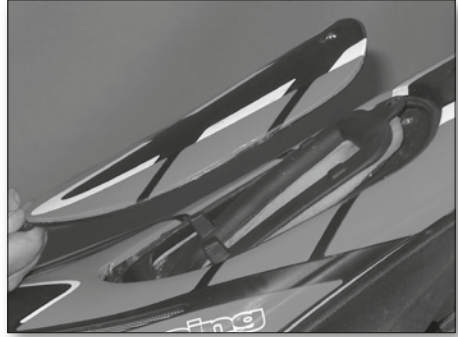
**SPARKPLUG**

Keeping the sparkplug in good condition helps to reduce fuel consumption and keep the engine running optimally.

To check it, just pull off the plug cap and unscrew the sparkplug.

Check the gap between the electrodes with a feeler gauge: it should be 0.6-0.7 mm. If it is not within this range, you can adjust it

by bending the negative electrode. Take care not to damage the central electrode.

Check also that there are no cracks in the insulation or corroded electrodes. If you find either of these faults, replace the sparkplug immediately.

Check the sparkplug at the intervals given in the table on page 29.

The best way to fit the sparkplug is to screw it in by hand until it will go no further, then lock it with a spanner.

Note:

We recommend that you always use NGK CR7EB sparkplugs.

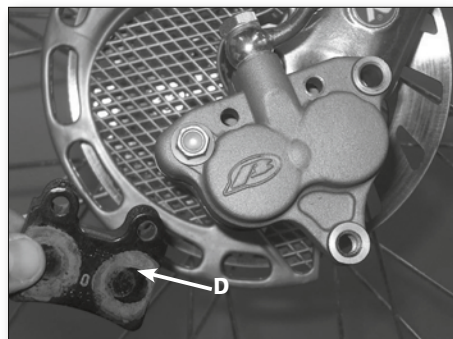
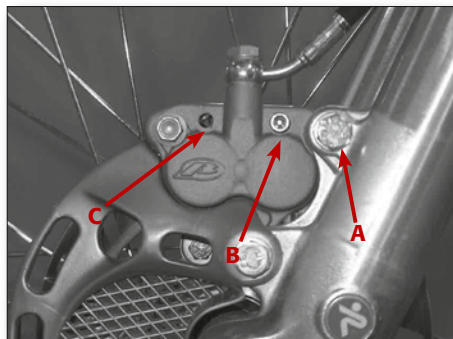

FRONT BRAKE

Checking

To check the state of wear of the front brake, you only need look at the caliper from the front, which gives a view of the ends of the two brakepads. The pads must have a layer of friction material at least 2 mm thick. If it is thinner than this, replace the pads immediately.

Note:

Check the brakepads at the intervals given in the table on page 29.

Replacing the brakepads

To replace the pads, follow the steps below:

- Remove the disc cover and the caliper by unscrewing the two bolts indicated by the letter A and slacking off screw B.
- Slide out the retaining pin (C).
- Undo screw B.
- Take out the pads (D) and replace them.
- To refit the pads, follow these steps in reverse.

Note:

Take particular care to refit the retaining pin correctly, to avoid braking problems.

If the brake disc is removed, some suitable thread lock should be applied to the bolts when refitting.

REAR BRAKE

Checking

To check the state of wear of the rear brake, you only need look at the caliper from the rear, which gives a view of the ends of the two brakepads. The pads must have a layer of friction material at least 2 mm thick. If it is thinner than this, replace the pads immediately.

Note:

Check the brakepads at the intervals given in the table on page 29.

Replacing the brakepads

To replace the pads, follow the steps below:

- Slack off nut A.
- Move the wheel forward and remove the chain from the rear sprocket.
- Pull out the wheel spindle and remove the wheel.
- Remove the brake caliper (B).
- Undo bolt C.
- Take out the pads and replace them.

To refit the pads, follow these steps in reverse. It is advisable to use medium-strength thread lock on bolt C.

If the brake disc is removed, medium-strength thread lock should be applied to the bolts when refitting.

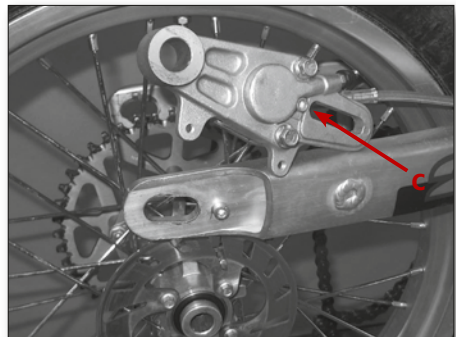
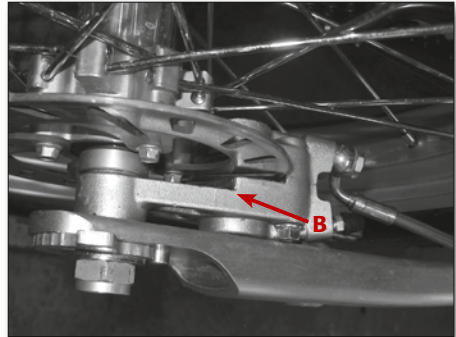
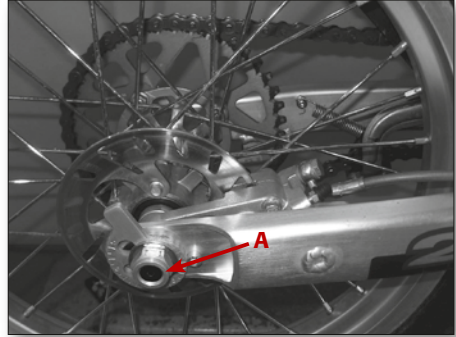

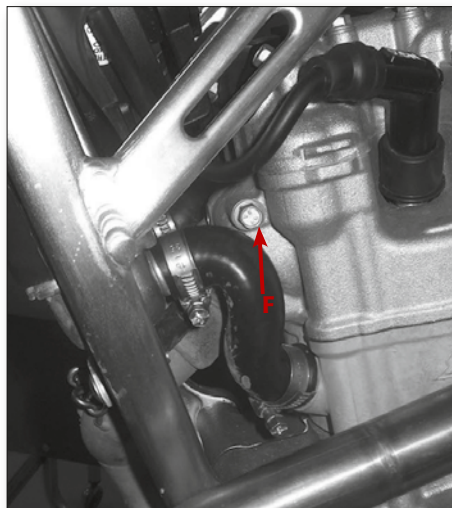
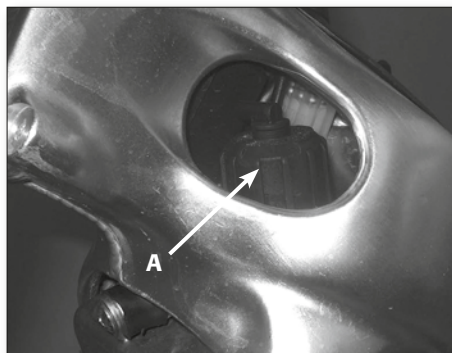
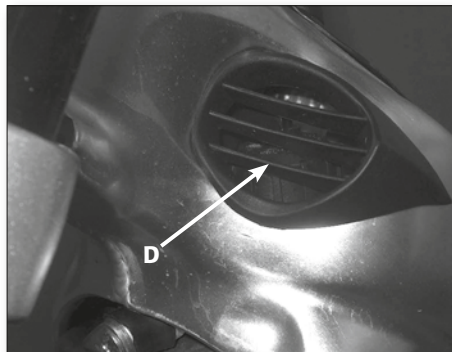

COOLANT

Check the level (this must be done with a cold engine) as follows:

- Remove the grille (D).
- Unscrew the filler cap (A) and visually check the fluid level.
- If the level is near the bottom of the tube, add fluid as follows:
- Add the coolant to the system through the radiator.
- Undo screw F located on the left-hand side of the cylinder head until the coolant comes out of the bleed hole.
- Tighten the bleed screw and continue pouring the liquid into the radiator until it reaches the flared section in proximity to the filler cap.

The capacity of the circuit is given in the table on page 7. Use the fluids recommended in the table on page 13.

CAUTION

To prevent scalding, never unscrew the radiator filler cap when the engine is hot.

CHECKS AFTER CLEANING

After you have cleaned the motorcycle, it is good practice to:

- Clean the air filter (as described on page 24).
- Get rid of any water from the inside of the carburettor float bowl, by unscrewing the drainscrew on the carburettor itself.

Note:

- This must be done with the reserve tap closed.*
- Grease the chain.*

SCHEDULED MAINTENANCE

Item	end of running in (3h)	after the first 10h	every 30h	every 60h
Air filter	I		I	I
Sparkplug		I	R	R
Fuel filter	I		I	I
Engine oil	R		R	R
Engine oil filter	R		R	R
Engine oil mesh filter	C		C	C
Brakes	I		I	I
Steering		I		I
Frame bolts/nuts	I		I	I
Liquids control		I	I	I
Valves		I		I
Piston rings				R
Head bolts	I			I

I = Inspect, clean, lubricate or replace as necessary

C = Clean

R = Replace

Chapter 4

Adjustments

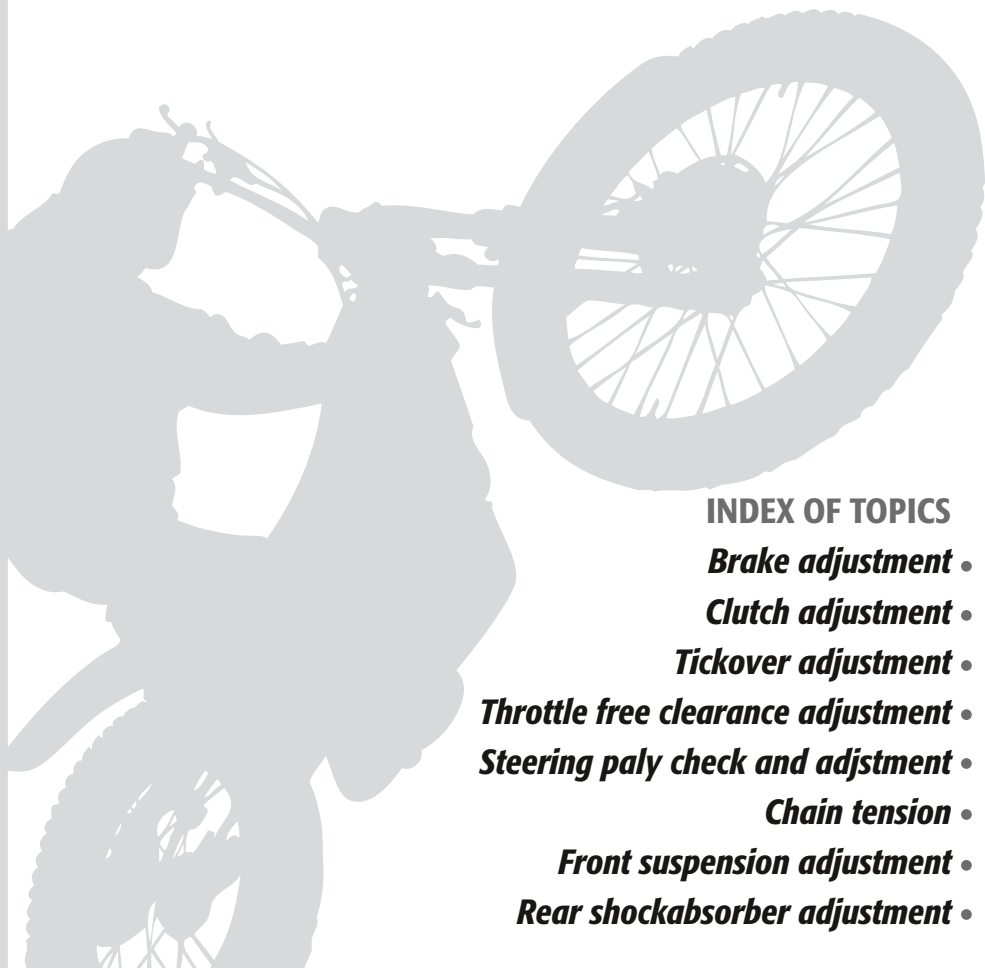

INDEX OF TOPICS

- Brake adjustment •***
- Clutch adjustment •***
- Tickover adjustment •***
- Throttle free clearance adjustment •***
- Steering paly check and adjstment •***
- Chain tension •***
- Front suspension adjustment •***
- Rear shockabsorber adjustment •***

BRAKE ADJUSTMENT

Front brake

The front brake is of disc type with hydraulic control, and for this reason it requires only ordinary maintenance. If you wish to adjust the position of the lever, use adjuster screw A. It is advisable to leave a minimum of play.

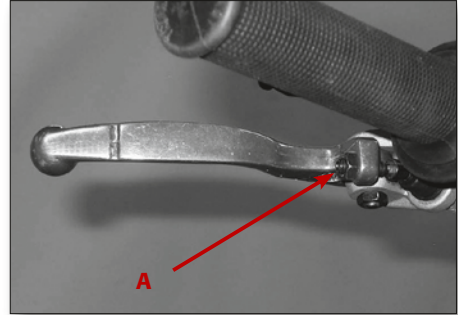

Rear brake

The rear brake is of disc type with hydraulic control.

You can alter the pedal height using adjusters B and C.

We recommend that you leave a minimum of free clearance.

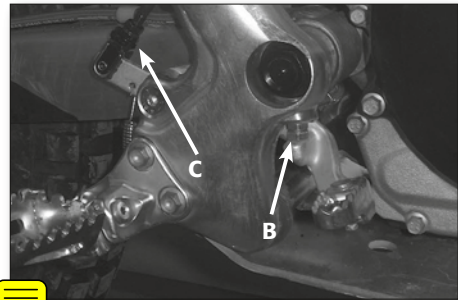

CLUTCH ADJUSTMENT

The only adjustment that can be made on the clutch is altering the position of the clutch lever E.

To make this adjustment, use adjuster D.

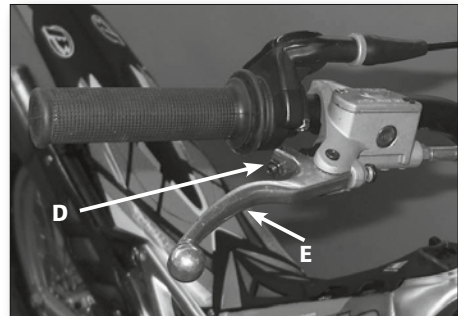

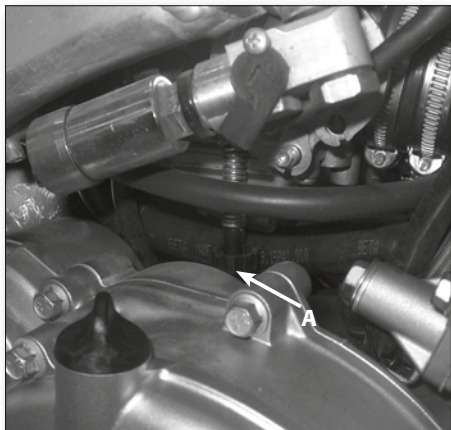

CARBURETTOR

Tickover adjustment

Tickover adjustment has a major influence on starting the engine. That is to say, an engine with a correctly adjusted tickover will be easier to start than an engine with incorrect tickover adjustment.

You adjust the tickover using the adjuster knob (A), which regulates the base position of the throttle valve.

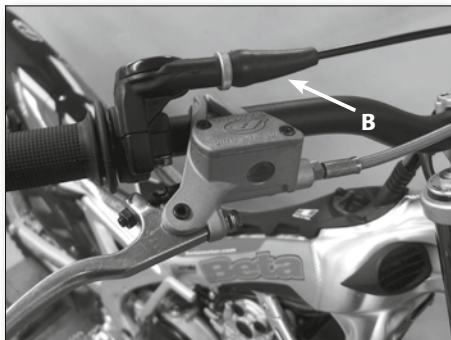

Throttle free clearance adjustment

To adjust the tension of the throttle cable, use adjuster B. If this amount of adjustment is insufficient, use adjuster C (on the throttle cable itself).

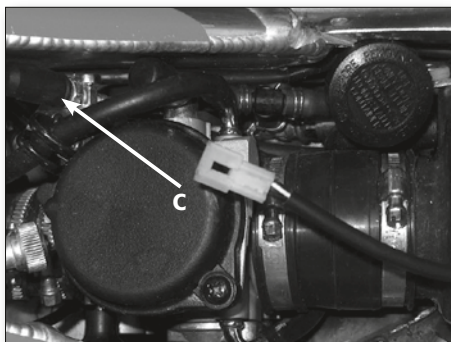

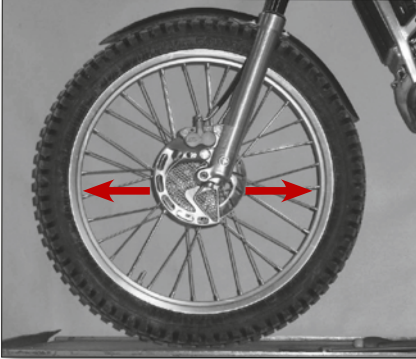

Steering clearance check and adjustment

Periodically check the clearance in the steering head by moving the forks backwards and forwards as shown in the illustration.

If you can feel clearance, adjust it by following these steps:

- Undo the four bolts (C).
 - Take off the handlebars (D).
 - Slacken nut E.
 - Take up the clearance by adjusting ringnut F.
- Follow this procedure in reverse for reassembly.

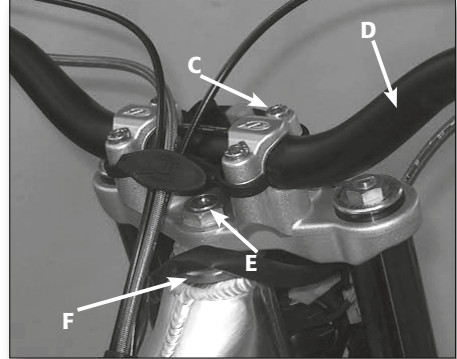

- Adjust with the same lever on the opposite side, taking it to the same position.
- Check the wheel alignment.
- Re-tighten nut A.

CHAIN TENSION

For a longer life for the final drive chain, we advise that you check its tension periodically.

Always clean off dirt deposits and lubricate it.

If the free clearance in the chain exceeds 20 mm, it needs tensioning as follows:

- Slack off nut A.
- Adjust with lever B.

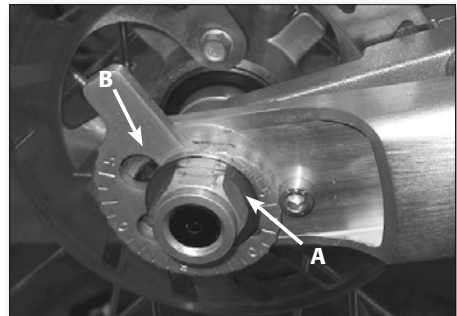
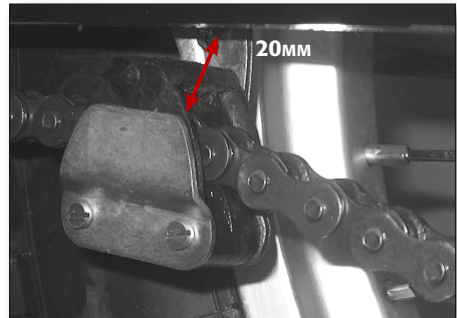

RIDER'S WEIGHT (Kg)	SPRING PRELOAD
weight > 80	+ 10 turns
75 < weight < 80	+ 5 turns
weight < 70	0

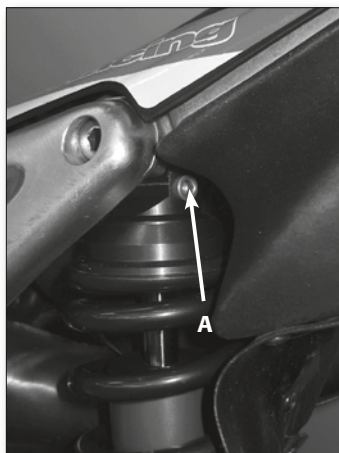
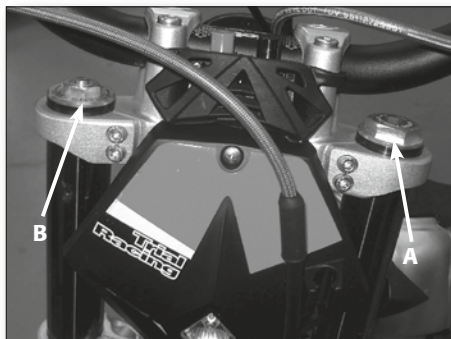

FRONT SUSPENSION ADJUSTMENT

Forks

- For a more reactive ride, unscrew adjuster knob B completely, with respect to the standard position.
- For a more controlled ride, preload the spring by about 4-5 turns, using screw A, and lock knob B 15 clicks from fully open (about mid-point in the range of adjustment).
- Rider's weight. Adjust to compensate for the rider's weight as follows:

In the event of any abnormality in operation, please contact our chain of authorised service centres.

REAR SHOCKABSORBER ADJUSTMENT

Information on adjustment

- For a more reactive ride, back off the compression adjustment screw (A).
- For a more controlled ride, tighten the compression adjustment screw (A).

Note:

For the standard adjustment, position the screw at +12 clicks from fully open.

- Periodically clean the working area of the buffer as follows:

Lower/remove the buffer, using a small screwdriver, and blow compressed air by means of the milling on the spring spacer.

- Always keep a check on the tightness of the upper and lower fixing bolts.

In the event of any abnormality in operation, please contact our chain of authorised service centres.

Chapter 5

What to do in an emergency



PROBLEM	CAUSE	CURE
THE ENGINE WILL NOT START	Fuel feed system obstructed (pipes, fuel tank, tap)	Clean out the system.
	Air filter excessively dirty	Follow procedure on page 20.
	No current getting to the sparkplug	Clean or replace the sparkplug. If the problem persists, contact one of our dealers.
	Engine flooded	With the throttle closed, active the Hot Start knob and operate the kick-start lever repeatedly.
	Drained floatbowl	Operate the manual tap as described on page 12.
THE ENGINE MISFIRES	Sparkplug with incorrect electrode gap	Set the electrode gap correctly. See note on page 21.
	Sparkplug dirty	Clean or replace the sparkplug.
	Earthing fault	Check insulation at kill switch.
POOR FRONT BRAKING	Pads worn, greasy or vitrified	Follow procedure on page 22.
	Air or moisture in hydraulic circuit	Follow procedure on page 16.
POOR REAR BRAKING	Pads worn, greasy or vitrified	Follow procedure on page 22.
	Air or moisture in hydraulic circuit	Follow procedure on page 16.